

ProHD

Model: DT-X93Hx2

9"x2 FHD Rack Mount LCD Monitor

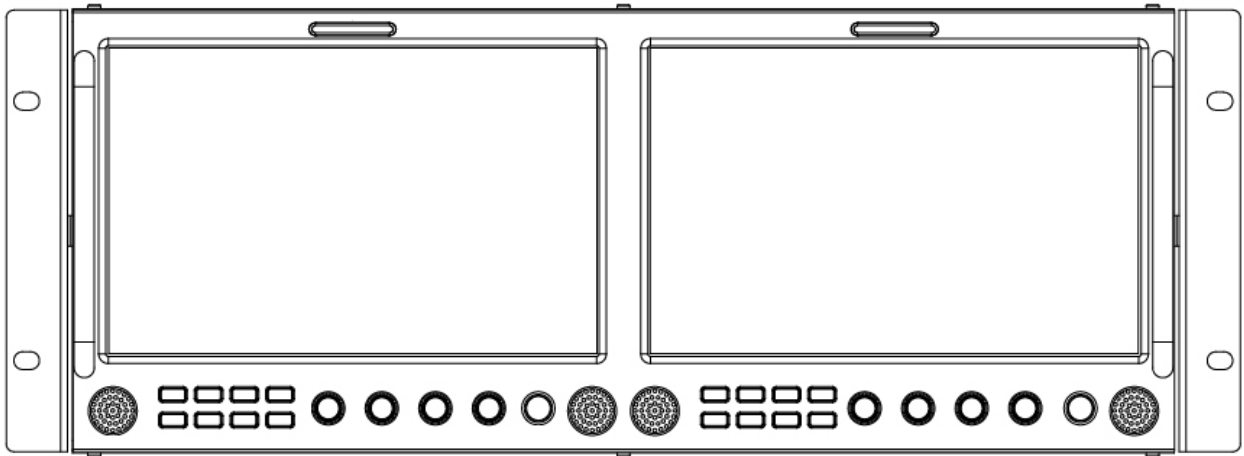

User Manual

Ver: A

Please read this User Manual
throughout before using.

Preface

1. All internal technologies of this product are protected, including device, software and trademark. Reproduction in whole or in part without written permission is prohibited.
2. All brands and trademarks are protected and other relative trademarks in this user manual are the property of their respective owners.
3. Due to constant effort of product development, SWIT Electronics reserves the right to make changes and improvements to the product described in this manual without prior notice.
4. The warranty period of this product is 2 years, and does not cover the following:
 - (1) Physical damage to the surface of the products, including scratches, cracks or other damage to the LCD screen or other externally exposed parts;
 - (2) The LCD dot defects are not over three;
 - (3) Any damage caused by using third-party power adaptors;
 - (4) Any damage or breakdown caused by use, maintenance or storage not according to the user manual.
 - (5) The product is disassembled by anyone other than an authorized service center.
 - (6) Any damage or breakdown not caused by the product design, workmanship, or manufacturing quality, etc.

Maintenance

Warning

1. In order to reduce the risk of fire and electrical shock, do not lay this product in rain or damp places.
2. Please keep away from the strong magnetic field; it may cause the noise of the video and audio signals.

The power

1. Please use the power adapter provided or recommended by the manufacturer in order to avoid damage.
2. For a third party power adapter, please make sure the voltage range, supplied power, and polarity of power lead are fit.
3. Please disconnect the power cable under the following situations:
 - (A). If you do not operate this monitor for a period of time;
 - (B). If the power cable or power adaptor is damaged;
 - (C). If the monitor housing is broken.

The monitor

1. Please don't touch the screen with your fingers, which would probably deface the screen.
2. Please don't press the screen; the LCD is extremely exquisite and flimsy.
3. Please don't lay this product on unstable place.

Cleaning

1. Please clean the screen with dry and downy cloth or special LCD cleanser.
2. Please do not press hard when cleaning the screen.
3. Please do not use water or other chemical cleanser to clean the screen. The chemical may damage the LCD.

Contents

- Preface2
- Maintenance3
- Contents4
- Installation Dimension5
- Operation Instructions6
 - Front Panel6
 - OSD**7
 - Back Panel.....9
- Sub-Menu..... 11
- Specification.....17
- Trouble-shooting.....18

Installation Dimension

The main body (in mm)

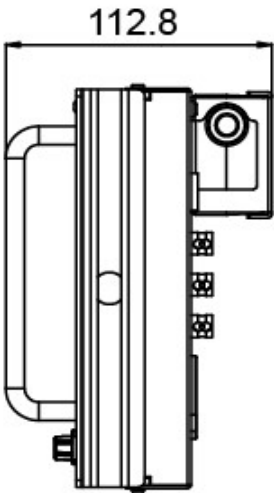
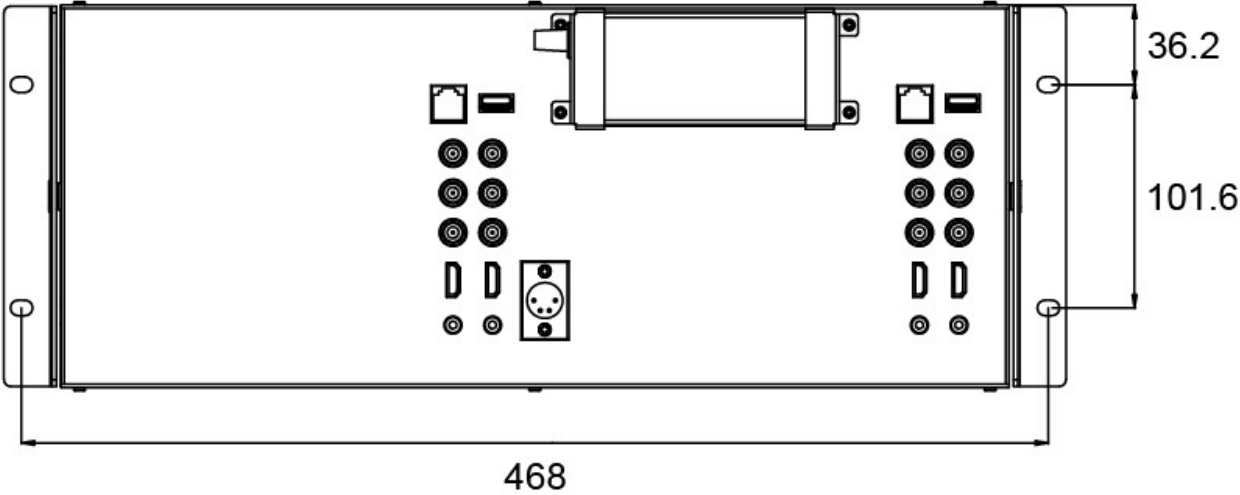
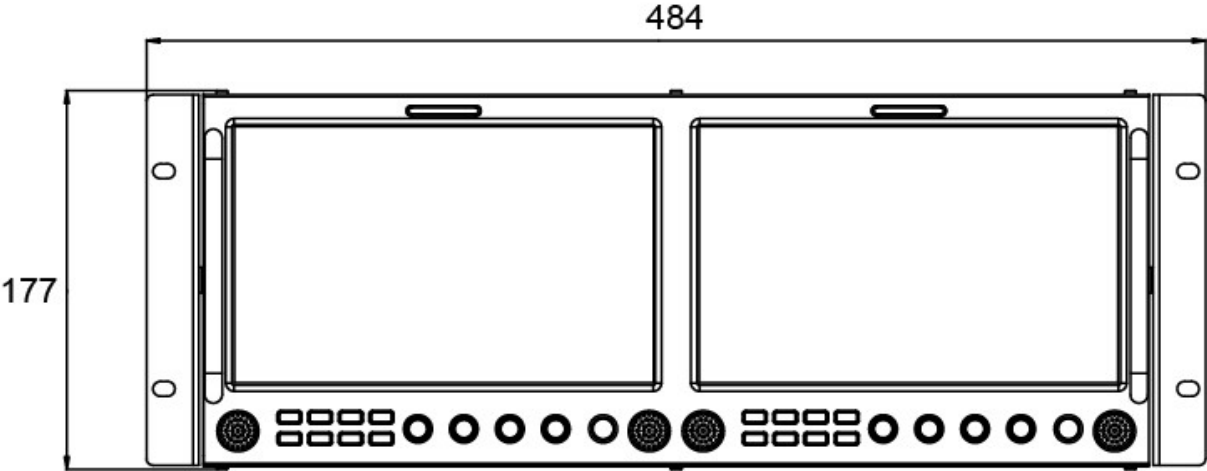

Operation Instructions

·Front Panel

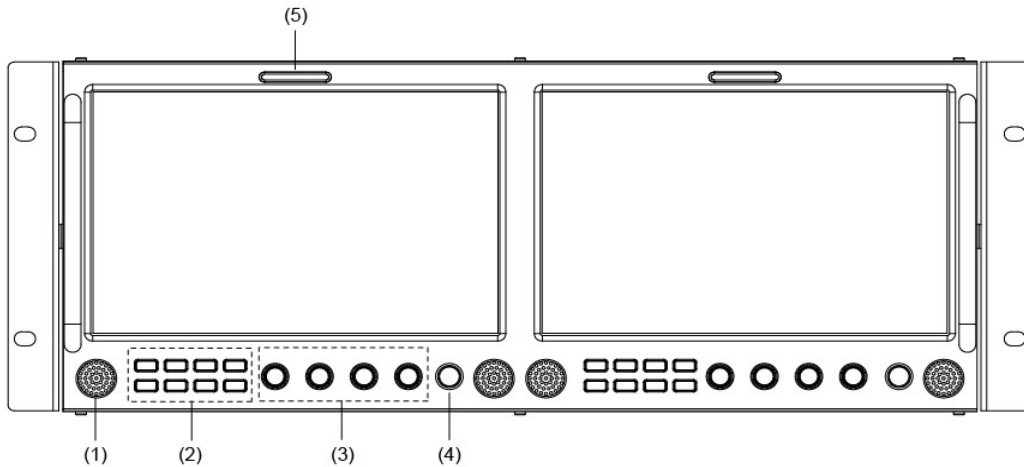

(1) Speaker: For SDI/HDMI embedded audio and analog audio monitoring.
(Will not work if headphone socket is plugged in)

(2) Button

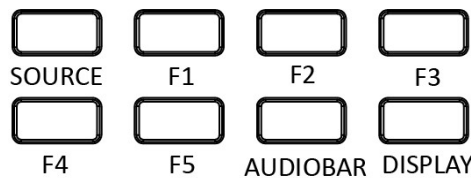

SOURCE: Press "SOURCE" to select SDI1, SDI2, HDMI, and CVBS signal input

F1~F5: User definable function keys. Please see details in "4. Function key" under "Main Menu".

AUDIOBAR: Press "AUDIOBAR" to turn on or turn off the audio meters display.

DISPLAY: Press "DISPLAY" to turn on or turn off relevant status information.

(3) Rotary Knob

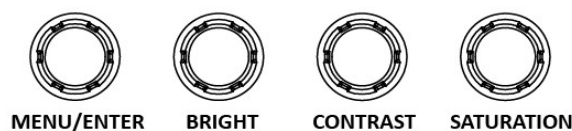

BRIGHT: 0-100 value adjustment and the default value is 50

CONTRAST: 0-100 value adjustment and the default value is 50

SATURATION: 0-100 value adjustment and the default value is 50

MENU/ENTER: When the menu is inactivated, presses "MENU/ENTE" to turn on the main menu;

Revolve "MENU/ENTER" to adjust settings or parameters, and press to apply;

When the menu is inactivated, revolve "MENU/ENTER" to adjust sound volume.

(4) POWER: Power on/off

(5) TALLY Light: Red, Green and Yellow 3-color TALLY indicator

·OSD

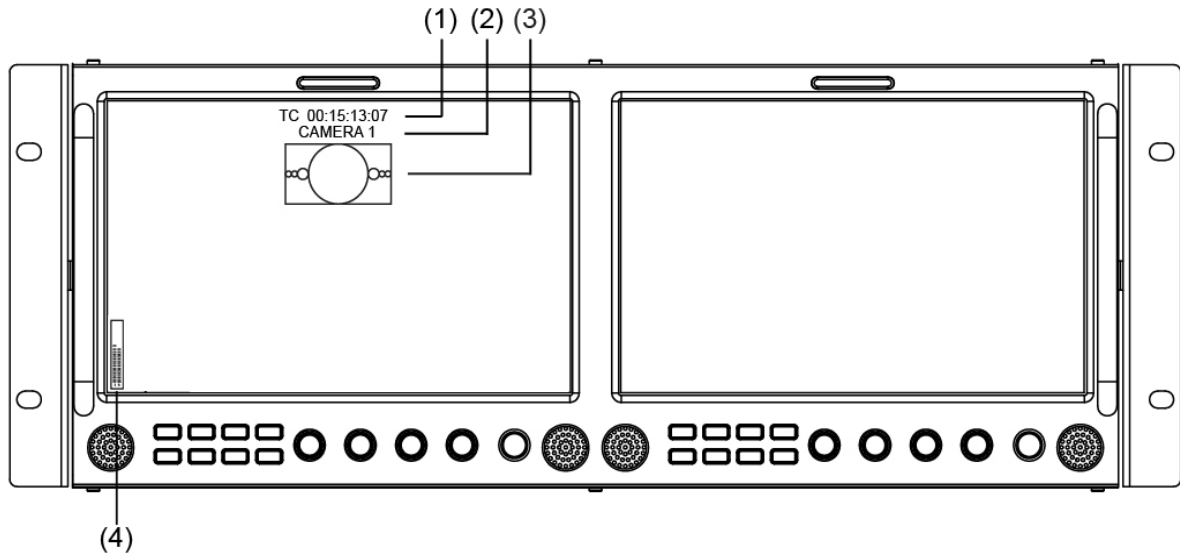

(1) Timecode (SDI)

Under SDI input, it can display Timecode. If no Timecode information is detected, it will be displayed as "TC: UNLOCKED".

User can set function keys F1~F5 or GPI pins as "Timecode" to turn on or off this function.

(2) UMD

Set up the UMD under 'UMD' submenu.

(3) AFD (SDI)

User can set function keys F1~F5 or GPI pins as "AFD" to turn on or off this function. If no relevant information is detected, it will be displayed as "AFD: UNLOCKED".

(4) Audio

Monitor the audio information. The relevant parameters like position, audio channels and blending, etc can be changed under "Audio" submenu.

User can set function Keys F1~F5 or GPI pins as "Audio" to turn on or off this function.

Introduction of audio and video functions

◆ 2-ch embedded audio meters

Under SDI and HDMI input, it displays 2 channels embedded audio meters, and under analog input, the monitor displays 2 channels analog audio meters. The audio meter is green, and will turn yellow when audio exceeds -20dB, and turn red when audio exceeds -9dB.

◆ Audio alarm

If the embedded audio value is too low or no audio input, it will display “MUTE” or “UNLOCKED” in the audio bar.

◆ Timecode (SDI)

Under SDI input, it can display the SMPTE timecode (VITC1, VITC2 or LTC) on the top of the screen, which is used extensively for synchronization, and for logging and identifying material in recorded media. If no Timecode information is detected, it will be displayed as “UNLOCKED”.

◆ Internal Color Bar

Under SDI and HDMI input, it has 100% internal color bar which helps to analyze the monitor color and adjust the display parameter.

User can set function Keys F1~F5 or GPI pins as “color bar” to turn on or off this function.

◆ Peaking focus assist (red/blue switch)

The Peaking focus assist function is to mark the sharpest edges of the image with red or blue color under SDI and HDMI input, for users to check if the subjects are focused.

User can set function Keys F1~F5 or GPI pins as “Focus Assist” to turn on or off this function.

◆ Zebra stripes

Zebra Stripes are used to check if the image is over exposed or not by showing black and white lines on the monitor. It is considered over exposed when luminance value exceeds 90%.

User can set function Keys F1~F5 or GPI pins as “Zebra” to turn on or off this function.

◆ Freeze Frame

The freeze frame is to capture and display the current broadcast frame.

User can set function Keys F1~F5 or GPI pins as “Freeze Frame” to turn on or off this function.

◆ R/G/B/Mono

R/G/B/Mono is to display only the blue/red/green primary signal or the luminance signal only so as to monitor the image noise.

User can set function Keys F1~F5 or GPI pins as “R/G/B/Mono” to turn on or off this function.

◆ False Color

The false color is used to aid in the setting of camera exposure. Under false color mode, there's a color chart on the bottom of screen for reference. The color from the dark to the bright will be displayed as blue, cyan, green, yellow, orange and red in a consecutive way. User can set function Keys F1~F5 or GPI pins as “False color” to turn on or off this function.

◆ AFD (SDI)

It is the abbreviation of active format description. AFD is to display the SDI embedded AFD information graphically on the screen.

◆ H/V Delay (SDI)

Under SDI input, H/V Delay can be used to display line/field blanking signal, and to observe the horizontal and vertical synchronous signal.

◆ UMD

When using external control unit, it can display the video source ID and tally information on the screen.

◆ Flip and Rotate

The image can be set up/down flip, or left/right mirror display, like:



Normal

Left to right

Up to down

180° Rotate

• Back Panel

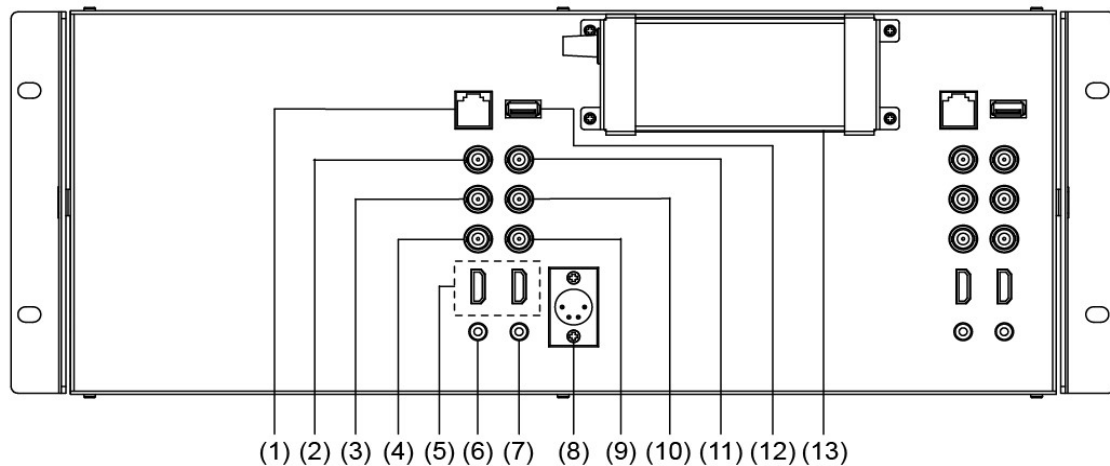

- (1) GPI: TSL UMD&GPI control socket
- (2) SDI-LOOP1: SDI loop through output from SDI-IN1 (BNC)
- (3) SDI-LOOP2: SDI loop through output from SDI-IN2 (BNC)
- (4) CVBS-OUT: CVBS through output from CVBS-IN (BNC)
- (5) HDMI Socket
HDMI-IN: HDMI input (HDMI-A)
HDMI-OUT: HDMI loop through output from HDMI-IN (HDMI-A)
- (6) AUDIO IN: 3.5mm analog audio input
- (7) AUDIO OUT: 3.5mm audio output, SDI/HDMI embedded audio and analog audio output
- (8) DC IN: Connect with 4-pin XLR power adapter, support 6.5V-24V voltage input (Pin 1: Negative, Pin 4: Positive)
- (9) CVBS-IN: CVBS input (BNC)
- (10) SDI-IN2: SDI input (BNC)
- (11) SDI-IN1: SDI input (BNC)
- (12) USB: User firmware upgrade socket
- (13) AC-DC Power Adaptor

Main Menu

DT-X93Hx2 has OSD to adjust the parameters and settings, for example: Picture, color temp., function keys, etc.

1. Press “MENU/ENTER” button, the main menu will pop-up from the left top of the screen. The selected main menu highlights in yellow.

Main Menu		Status
Exit&Status	>	HDMI XXX
Picture	>	User Profile XX
Color Temp	>	Color Temp XXXX
Function Key	>	Scan Mode XXX
GPI	>	Freeze Frame XXX
UMD	>	F1 XXX
Marker	>	F2 XXX
Audio	>	F3 XXX
Vector	>	F4 XXX
Waveform	>	F5 XXX
Display	>	System Version XXX
System	>	
OSD	>	
Key Inhibit	>	

2. Revolve “MENU/ENTER” to select submenu, the selected submenu highlights in yellow, press “MENU/ENTER” to apply and enter into the selected submenu’s items.

3. Revolve “MENU/ENTER” to select the item which needed to adjust, press “MENU/ENTER”, the selected item and its parameters will be highlighted in yellow.

Main Menu		XXXX
Exit&Status	>	Exit
Picture	>	Marker XX
Color Temp	>	Marker Select 15:9
Function Key	>	Safety Area XXX
GPI	>	Fit Marker XXX
UMD	>	Center Marker XXX
Marker	>	Marker Color XXX
Audio	>	Marker Outside XXX
Vector	>	
Waveform	>	
Display	>	
System	>	
OSD	>	
Key Inhibit	>	

4. Revolve “MENU/ENTER” to change the selected item’s parameter, press “MENU/ENTER” to apply and save the settings.

5. Revolve “MENU/ENTER” to select “Exit”, press “MENU/ENTER” to quit submenu. Select “Exit & Status” under the Main Menu and press to quit Main Menu.

Notice:

- * The items in gray cannot be set up.
- * If there is no operation under the set time, the menu will automatically save settings and quit.
- * If the key inhibit function is turned on, except key inhibit function, all other items are in grey. Please turn off the key inhibit function to adjust the items.

Sub-Menu (the default values are marked with underline)

1. Exit & Status

Displays the current status, the details are as down below:

Exit&Status	HDMI ^{*1}	1080p@50Hz
	User Profile	Factory
	Color Temp	6500K
	Scan Mode	Normal
	Freeze Frame	Off
	Odd/Even Frame	Off
	F1 ^{*2}	Time Code
	F2	Focus Assist
	F3	Zebra
	F4	Marker
	F5	Mute
	System Version	VXXX-XX

*1 Display the current video signal and format

*2 Display the current function keys setup

2. Picture

To adjust picture parameters

Picture	Exit	
	Contrast	0-100, <u>50</u>
	Brightness	0-100, <u>50</u>
	Saturation	0-100, <u>50</u>
	Sharpness	0-100, <u>50</u>
	Hue	0-100, <u>50</u>
	Backlight	0-100, <u>50</u>

3. Color Temp

To select different color temperature or setup user-defined color parameters.

Color Temp	Exit	
	Gamma	2.2、 <u>2.4</u> 、2.6
	Color Temp	<u>6500K</u> 、5600K、9300K、User
	Red Gain	0-255, 128
	Green Gain	0-255, 128
	Blue Gain	0-255, 128
	Red Bias	0-255, 128
	Green Bias	0-255, 128
	Blue Bias	0-255, 128

* Only "Color Temp" is set to "User", the Red/Blue/Green Gain or Red/Blue/Green Bias can be adjusted.

4. Function key

To define the F1~F5 function keys.

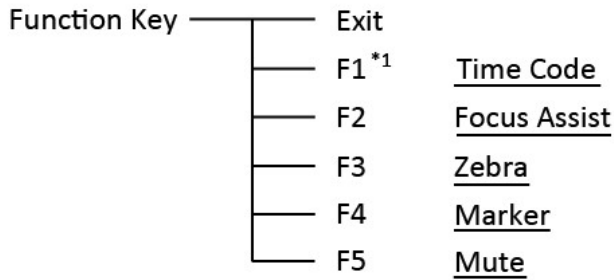

*1 Function keys F1-F5 can be set as the down below functions:

Timecode, Zebra, Audio Bar, False Color, AFD, H/V Delay, R/G/B/Mono, Marker, Color Bar, UMD, Audio Alarm, Focus Assist, Aspect Ratio, Scan Mode, Zoom Mode, Mute, Freeze Frame, Flip, CVBS, HDMI, SDI1, SDI2, Color Temp.

5. GPI

User can set GPI pins to relevant functions to turn on or off this function.

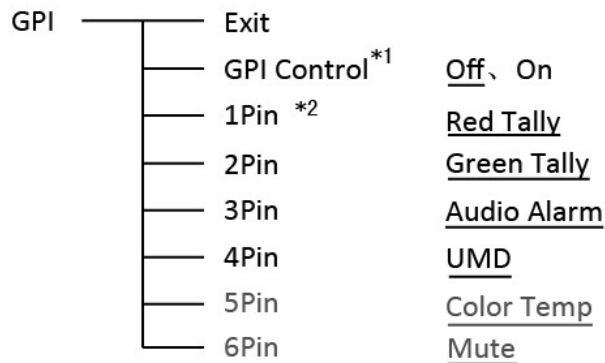

*1 When "GPI control" is set to "On", the monitor can be operated through external GPI control unit.

*2 The GPI pins can be set to the down below functions:

Red Tally, Green Tally, Yellow Tally, Aspect Ratio, Scan Mode, Zoom Mode, Mute, Freeze Frame, Flip, Color Temp, Time Code, Zebra, Audio Bar, False Color, AFD, H/V Delay, R/G/B/Mono, Marker, Color Bar, UMD, Audio Alarm, Focus Assist.

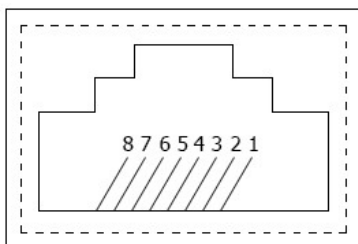

Pin	1	2	3	4
GPI	GPI_1	GPI_2	RXD+	GPI_3
Pin	5	6	7	8
GPI	GPI_4	RXD-	NC	GND

When connecting the GPI pin with ground, the setted function will be turned on, and goes out when disconnecting.

Example 1: Under "GPI" submenu, set "GPI control" to "On", set "2 Pin" to "Red Tally", when the pin 2 of the external GPI control unit is connected with ground, the Tally light on the front panel will turn red. When disconnected, the tally light will turn off.

Example 2: Under "GPI" submenu, set "GPI control" to "On", set "6 Pin" to "Scan Mode", when the pin 6 of the external GPI control unit is connected with ground, the Scan mode will change and follow the sequence: "Normal" → "Overscan" → "Native".

6. UMD

Support "TSL UMD Protocol-V4.0" provided by Television System LTD

UMD	Exit	
	RS485 Address	<u>1-126</u>
	Position	<u>Top</u> 、Bottom
	Display Type	<u>Source ID</u> 、UMD
	Baud Rate	<u>38400</u> 、9600、19200
	Parity	<u>Even</u> 、None
	Serial Port	RS485
	Source ID	<u>CAMERA 1</u>

Source ID Setup:

Select "Source ID", revolve "MENU/ENTER" to select the letters and press "MENU/ENTER" to input. Max 8 letters are supported. Select "Exit" to quit and save settings, the source ID will be displayed on top or bottom of the screen.

UMD setup:

- (1) Connect the external control equipment;
- (2) Set "Display Type" to "UMD";
- (3) Set "address", "Baud Rate" and "Parity"
- (4) Adjust the external control equipment and send UMD command, the monitor will display as: User can set the character and color of the UMD and the color of Tally1 and Tally2.

Please see "5. GPI" to check the "RS485 pin sequence and definition:

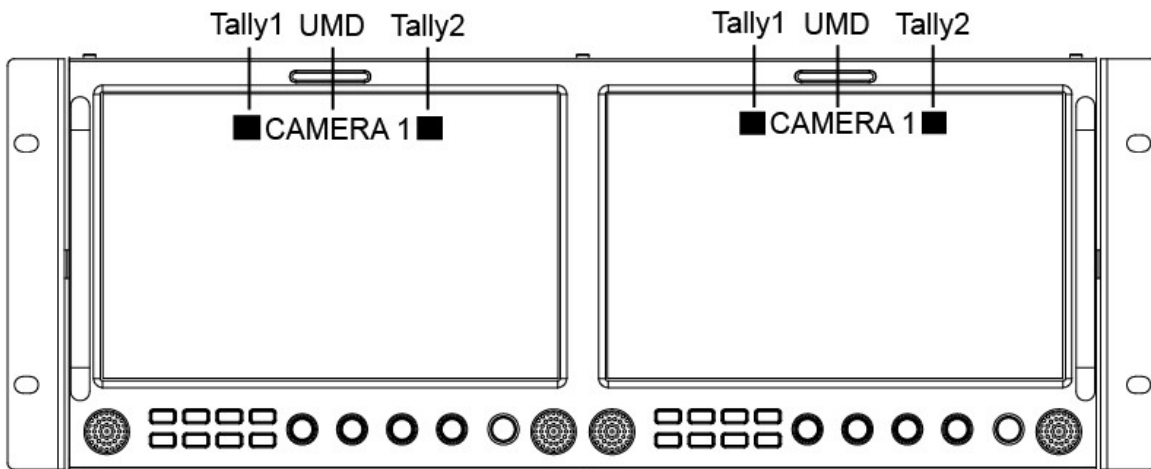

User can set the character and color of the UMD and the color of Tally1 and Tally2.

Please see "5. GPI" to check the "RS485 pin sequence and definition:

7. Marker

Marker	Exit	
	Marker	<u>Off</u> , <u>On</u>
	Marker Select	<u>Off</u> , 4:3, 13:9, 14:9, 15:9, 16:9, <u>1.85:1</u> , 2.35:1
	Safety Area	<u>Off</u> , 80%, 85%, <u>90%</u> , 93%, 95%
	Fit Marker*1	<u>Off</u> , <u>On</u>
	Center Marker	<u>Off</u> , <u>On</u>
	Marker Color	<u>White</u> , Red, Green, Blue, Black, Gray
	Marker Outside	<u>Off</u> , <u>Gray</u> , Black

*1 When “Fit Marker” is “Off”, the size of safety area is benchmarked against the actual display screen, accounting for 80% ~ 95% of actual display screen. When “Fit Marker” is “On”, the size of safety area is benchmarked against the area inside the scales marker, accounting for 80% ~ 95% of the area inside the scales marker.

Example:

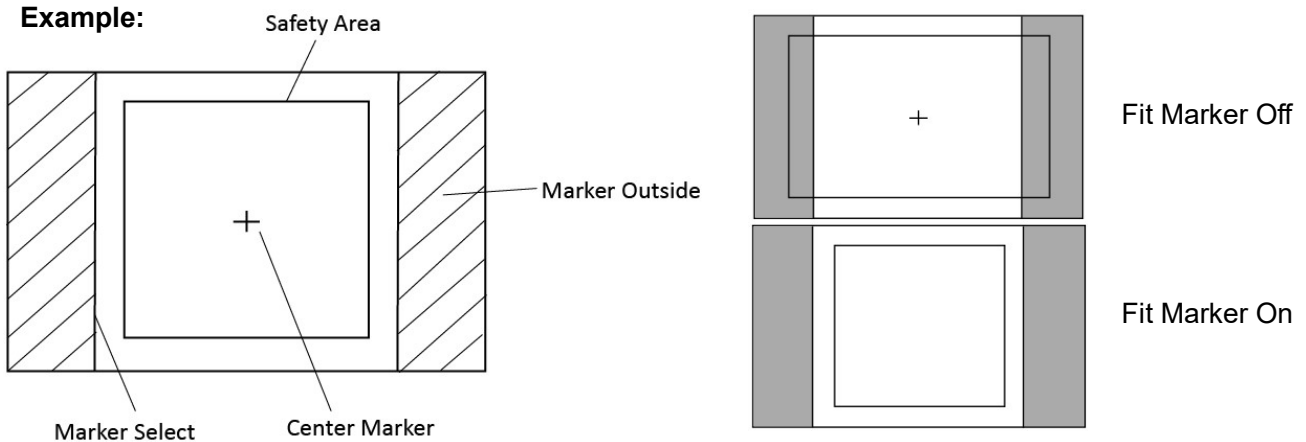

8. Audio

Audio	Exit	
	Audio Bar	<u>Off</u> , <u>On</u>
	Bar Frame *1	<u>Off</u> , <u>On</u>
	Bar Position	<u>Top Right</u> , Bottom Left, Bottom Right, Top Left
	Bar Blending	<u>Low</u> , <u>Off</u> , High
	Audio Alarm*2	<u>Off</u> , <u>On</u>
	Select Channel	Channel 1-2
	Left Channel *3	CH1-CH2, <u>CH1</u>
	Right Channel	CH1-CH2, <u>CH2</u>

*1 When “Bar Frame” is set to “Off”, only the audio meter will be displayed. When “Bar Frame” is set to “On”, frame and real-time audio value will be displayed.

*2 When “Audio Alarm” is set to “On”, if no embedded audio is detected, the audio bar will display “UNLOCKED”. If the audio value is too low, the audio bar will display “MUTE”.

*3 Select Channel

Under SDI signal, user can set output audio from channel 1 or channel 2

9. Display

Display	Exit	
	Waveform	Off
	Audio Bar	<u>Off</u> 、On
	Vector	Off
	Zebra	<u>Off</u> 、On
	Focus Assist	<u>Off</u> 、Blue、Red
	Time Code	<u>Off</u> 、On
	Histogram	Off
	False Color	<u>Off</u> 、On
	AFD	<u>Off</u> 、On
	H/V Delay	<u>Off</u> 、On
	R/G/B/Mono	<u>Off</u> 、Blue Only、Red Only、Green Only、Mono
	Color Bar	<u>Off</u> 、On
	Marker	<u>Off</u> 、On
	UMD	<u>Off</u> 、On

10. System

System	Exit	
	Aspect Ratio	<u>16:9</u> 、4:3、Auto
	Scan Mode	<u>Normal</u> 、OverScan、Native
	Zoom Mode	<u>Off</u> 、Zoom1、Zoom2
	Odd/Even Frame	Off
	Color Space	Auto
	Freeze Frame	<u>Off</u> 、On
	Flip Mode	<u>Off</u> 、H Flip、V Flip、H/V Flip
	Recall Profile	<u>Factory</u> 、User1、User2、User3
	Save Profile	<u>User1</u> 、User2、User3
	Source Scan	<u>On</u> 、Off
	Logo	<u>On</u> 、Off
	Green Mode	Black Backlight
	Idle Duration	2Hours
	Update Driver	<u>No</u> 、Yes
	Update Kernel	<u>No</u> 、Yes

*1 Source Scan

When set to “Yes”, after turn on the monitor, the signal will be inspected and follow the sequence of “SDI1→SDI2→HDMI→CVBS”.

For example: if channel is selected to SDI2, SDI-IN2 has no input, and CVBS has input. When turn on the monitor, after automatic inspection, SDI2 has no recognized signal, and CVBS has recognized signal, then the input signal will be CVBS.

When set to “No”, update model will not be supported.

*2 Logo

When powered on, the screen will display ProHD logo.

*3、 *4 Update Driver/ Kernel

Download latest firmware files in USB disk - root directory.

Switch on the monitor, and insert USB disk into the USB socket on rear panel.

Enter Menu – System – Update Driver, select YES and the monitor will upgrade automatically, and will restart when upgrade finished.

Enter Menu – System – Update Kernel, select YES and the monitor will upgrade automatically, and will restart when upgrade finished.

Please DO NOT cut off power during firmware upgrade.

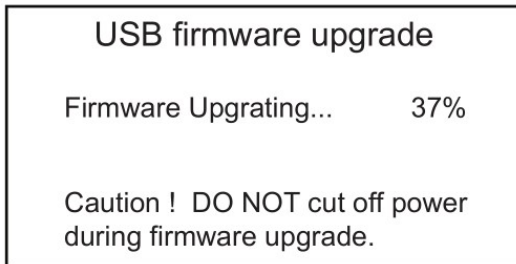

11. OSD

OSD	Exit	
	OSD Language	<u>English</u> 、 Chinese
	OSD Blending	<u>Low</u> 、 Medium、 High、 Off
	OSD Duration	<u>10Sec</u> 、 15Sec、 30Sec、 60Sec
	OSD Zoom	Off、 <u>On</u>
	Key Led Brightness	<u>Low</u>
	Tally-R Brightness	<u>High</u> 、 Low、 Medium
	Tally-G Brightness	<u>High</u> 、 Low、 Medium

12. Key Inhibit

Key Inhibit	Exit	
	Key Inhibit	<u>Off</u> 、 On

If the “Key Inhibit” is “On”, there is no response when all the buttons except ” MENU/ENTER” are pressed, the screen will be displayed as ” Key Inhibit”.

Specification

LCD Performance		
Size	9 inches ×2	
Display area	191.5×119.7 mm	
Resolution	1920×1200	
Color	8 bit	
Aspect ratio	16:9 / 4:3	
Brightness	450 cd/m ²	
Contrast	1000:1	
Viewing Angle	Horizontal: 170° Vertical: 170°	
Input/output – Each LCD		
Input	BNC×2	2K/3G/HD/SD-SDI ×2
	BNC×1	CVBS input
	HDMI×1	HDMI input
	GPI×1	UMD, GPI control input
	USB×1	For firmware upgarde
	3.5mm×1	analog audio input
Output	BNC×2	2K/3G/HD/SD-SDI loop through output ×2
	BNC×1	CVBS loop through output
	HDMI×1	HDMI loop through output
	3.5mm×1	SDI/HDMI/analog audio output
Video Format		
CVBS	NTSC / PAL	
HDMI	480i / 576i / 480p / 576p	
	1080i (60 / 59.94 / 50)	
	720p (60 / 59.94 / 50)	
	1080p (60 / 59.94 / 50 / 30 / 29.97 / 25 / 24 / 23.98)	
SDI	SMPTE-2048-2	2048×1080p (23.98 / 24 / 25 / 29.97 / 30 / 50 / 59.94 / 60)
		2048×1080i (50 / 59.94 / 60)
	SMPTE-425M-A/B	1080p (60 / 59.94 / 50)
	SMPTE-274M	1080i (60 / 59.94 / 50)
		1080p (30 / 29.97 / 25 / 24 / 23.98)
	SMPTE-RP211	1080psf (30 / 29.97 / 25 / 24 / 23.98)
	SMPTE-296M	720p (60 / 59.94 / 50)
SMPTE-125M	480i (59.94)	
ITU-R BT.656	576i (50)	
General		
Input voltage	DC 6.5V-24V	
Power consumption	36W	
Working temperature	0°C~+40°C	
Working humidity	10%~90%	
Storage temperature	- 15°C~ + 60°C	
Storage humidity	10%~90%	
Dimensions	484×177×112.8mm	
Net weight (main body)	2.8 kg	

Trouble-shooting

Symptom	Possible Causes	Solution
No display	The power is not turned on	Please check if the power is connected, and then press "POWER" button to turn on the monitor
	Unstable power voltage	Reconnect to power supply
	BNC or HDMI cable loose contact or not correctly connected	Check and correctly connect the BNC or HDMI cable
	The attached battery is no power	Change battery
	Using DIY power supply but the polarity is reversed	Refer to the provided power supply, reconnect the power.
Image or color abnormal	Bad contact of BNC or HDMI cable	Change cable
	Video signal has Interference	Remove the interference source(s)
	Improper adjustment of the color parameters	Adjust the "Recall profile" to "Default" under "System" submenu
	Distortion of the image	Reset the Aspect ratio
	Set to Red/Green/Blue only or Mono	Turn the Blue only/ Red Only/ Green Only/Mono off under R/G/B/Mono submenu
	Turn on the "Focus Assist" function	Turn off the "Focus Assist" function
	Turn on the "False Color" function	Turn off the "False Color" function
No audio output	Set to Mute	Turn off MUTE or revolve "MENU/ENTER" to adjust the volume
	Bad contact of signal cable	Change signal cable
	Wrong connection or bad contact of Audio cable	Connect to the correct input socket.

ProHD

This model is manufactured, warranted and supported by **SWIT Electronics Co., Ltd. / SWIT Electronics USA, LLC**, and distributed in North America by **JVCKENWOOD USA Corporation**

To obtain service or for further information, please contact:

SWIT Electronics USA, LLC.

Address: 3350 Scott Blvd. 61-02, Santa Clara, CA 95054

Toll free: 1 866 986-SWIT (7948) • Tel: 408 260-8258 • Fax: 408 228-8438

Email: info@swit.us • Website: www.swit.us